

Technical Data Table

Technical specification

Efficiency data		Unit	HM051MR U44	HM071MR U44	HM091MR U44 HM093MR U44	HM121MR U34 HM123MR U34	HM141MR U34 HM143MR U34	HM161MR U34 HM163MR U34
Seasonal space heating eff. class (35°C / 55°C)	-		A+++ / A++	A+++ / A++	A+++ / A++	A+++ / A++	A+++ / A++	A+++ / A++
Seasonal space heating efficiency (η_s) (35°C / 55°C)	%		175 / 125	176 / 125	179 / 125	184 / 136	182 / 135	178 / 135
SCOP (35°C / 55°C)	-		4.46 / 3.20	4.48 / 3.20	4.55 / 3.20	4.67 / 3.47	4.62 / 3.46	4.53 / 3.45
Nominal capacity and COP / EER								
Air +7°C / water +35°C	Heating capacity / COP	kW / -	5.50 / 4.70	7.00 / 4.70	9.00 / 4.60	12.00 / 4.90	14.00 / 4.80	16.00 / 4.70
Air +2°C / water +35°C	Heating capacity / COP	kW / -	4.40 / 3.60	5.60 / 3.55	6.80 / 3.50	11.00 / 3.65	12.00 / 3.63	13.80 / 3.60
Air +7°C / water +55°C	Heating capacity / COP	kW / -	5.50 / 2.70	5.50 / 2.70	5.50 / 2.70	11.00 / 2.90	11.50 / 2.85	12.00 / 2.80
Air +35°C / water +18°C	Cooling capacity / EER	kW / -	5.50 / 4.70	7.00 / 4.70	9.00 / 4.60	12.00 / 4.75	14.00 / 4.30	16.00 / 4.00
Air +35°C / water +7°C	Cooling capacity / EER	kW / -	5.50 / 3.30	7.00 / 3.20	9.00 / 3.10	12.00 / 3.30	14.00 / 3.30	16.00 / 3.10
Outdoor unit								
Operation range (outdoor air temperature)	Heating & DHW (Min. - Max.)	°C	-25 - 35					
	Cooling (Min. - Max.)	°C	5 - 48					
Operation range (leaving water temperature)	Heating (Min. - Max.)	°C	15 - 65					
	Cooling (Min. - Max.)	°C	5 - 27 (16 - 27) ²⁾					
	DHW (Min. - Max.)	°C	15 - 80 ³⁾					
Refrigerant	Type	-	R32					
	GWP	-	675					
	Precharged amount	g	1,400			2,000		
Piping connections (water)	Inlet / outlet diameter	inch	Male PT 1" according to ISO 7-1 (tapered pipe threads)					
Sound power level	Rated / low noise mode	dB (A)	57 / 54	57 / 55	60 / 56	61 / 57		
	Sound pressure level at 1 m ¹⁾	dB (A)	49 / 46	49 / 47	52 / 48	53 / 49		
	Sound pressure level at 5 m ¹⁾	dB (A)	35 / 32	35 / 33	38 / 34	39 / 35		
Dimension	W × H × D	mm	1,239 × 834 × 330			1,239 × 1,380 × 330		
Weight	Empty	kg	89.5	1 Ø: 89.5 / 3 Ø: 90.0		119.1		
Exterior	Color / RAL code	-	Warm gray / RAL 7044					
Power supply	Voltage, phase, frequency	V, Ø, Hz	220 - 240, 1, 50			220 - 240, 1, 50 380 - 415, 3, 50		
	Recommended circuit breaker	A	16	20	1 Ø: 25 / 3 Ø: 16		1 Ø: 40 / 3 Ø: 16	

1) Sound pressure level is converted from sound power level based on a tonality penalty of 0 dB and installation in free-field. The directivity index (Q) is assumed as 2.

2) When a fan coil unit is not used.

3) DHW 55 - 80°C operating is available only when the booster heater is operating.

Accessory backup heater

		Unit	HA031M E1	HA061M E1	HA063M E1	
Backup heater	Capacity combination	kW	3.0	3.0 + 3.0	2.0 + 2.0 + 2.0	
	Power supply	V, Ø, Hz	220 - 240, 1, 50			380 - 415, 3, 50
	Rated running current	A	12.5	25.0	8.7	



www.lg.com http://partner.lge.com

Copyright © 2023 LG Electronics. All rights reserved.



* Except for HM093MR U44

* Except for 14, 16 kW models

Silence Supreme, THERMA V Monobloc S

- Continuous heating comfort even in extreme weather conditions
- Compact Monobloc concept with no additional hydronic components
- Low noise level for high installation flexibility



Visit our website





A Ready-to-Install, Plug and Play Heat Pump

without an indoor unit. With its unique design, it requires only water piping connections, eliminating the need for additional refrigerant piping work. This not only simplifies installation but also ensures a space-efficient solution suitable for both new builds and renovations.

Key Features

- 5 to 16 kW for new built and renovation
- Space heating, cooling and DHW
- Maximum flow temperature up to 65°C
- Operation range down to -25°C
- Standalone heat pump

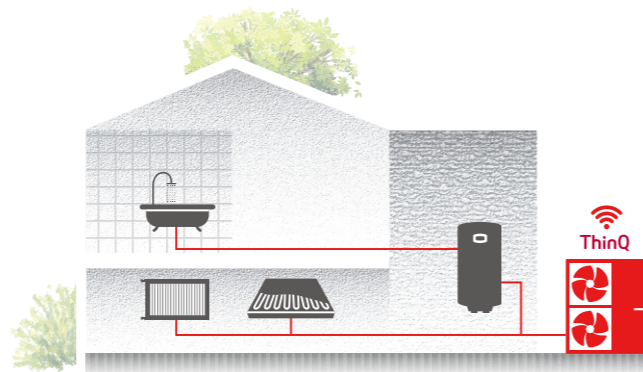

Product Range

Product	Capacity (kW)	Unit		Appearance
		1 Ø	3 Ø	
R32 Monobloc S	5	HM051MR U44	-	
	7	HM071MR U44	-	
	9	HM091MR U44	NEW HM093MR U44	
	12	HM121MR U34	HM123MR U34	
	14	HM141MR U34	HM143MR U34	
	16	HM161MR U34	HM163MR U34	



Why choose LG THERMA V Monobloc S?



01

Ready-to-install and space saving solution

- Integrated hydronic components in the package
- Easier and quicker installation without refrigerant piping work
- The best solution, when interior space is limited



02

Low noise level allowing installation flexibility

- Designed to reach lower noise levels in order to meet homeowner expectations in urban areas
- Noise reduction technology such as encapsulated compressor and vibration-decoupling to ensure a quieter and more comfortable experience
- Quiet Mark certified*

* Certified products are HM051MR U44 / HM071MR U44 / HM091MR U44 / HM093MR U44 / HM121MR U34 / HM123MR U34. This certification is valid for UK & EU territories only.



03

Remarkable heating performance even in cold weather

- 100 % heating capacity at -15°C ambient temp. (@ LWT 35°C, except for 16 kW model)
- Longer continuous heating periods with reduced defrost operation time and extended intervals





Tools & Services

For all customers including designers, installers, and end users.

LATS THERMA V ¹⁾

A web based simulation tool that enables to choose optimized THERMA V model from various capacity range and simulates its energy cost comparing to other heating solutions.

1) A web version will be available in 4Q 2023.

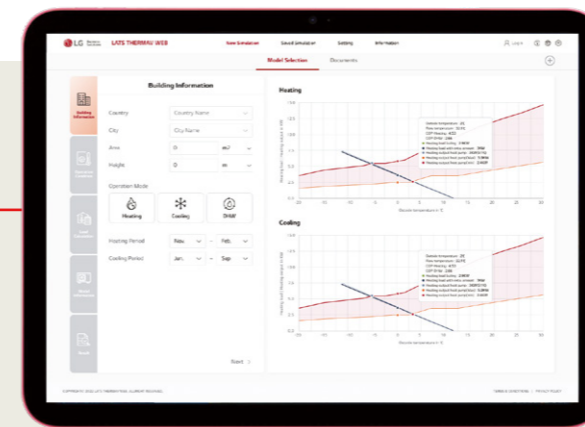

LG ThinQ & LG BECON cloud service

A cloud-based service that remotely monitors a customer's heating system via smart devices. End users can remotely control the heating system through ThinQ, and service providers can perform more detailed remote monitoring and diagnosis.

LG Smart Home Energy Package

Power your home the smart way and save the energy bill

With LG, you are able to minimize the energy cost and one step closer to the ultimate smart home.

* Availability of LG Smart Home Energy Package may vary by region.

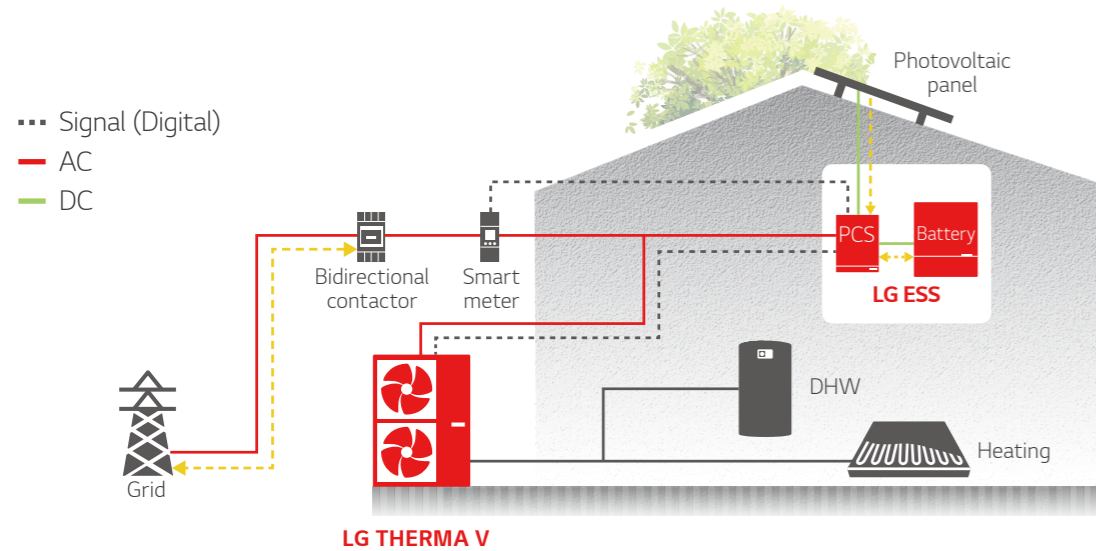

Accessories

Electric backup heater

- HA031M E1 (1 Ø, 3 kW)
- HA061M E1 (1 Ø, 6 kW)
- HA063M E1 (3 Ø, 6 kW)

Wi-Fi modem



Cloud gateway

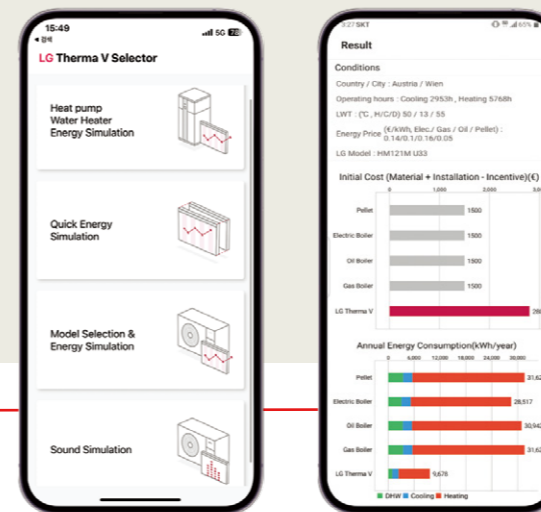

LG THERMA V Selector

A mobile app. for simulating energy consumption and cost as well as CO₂ emission.



Interior & Connections

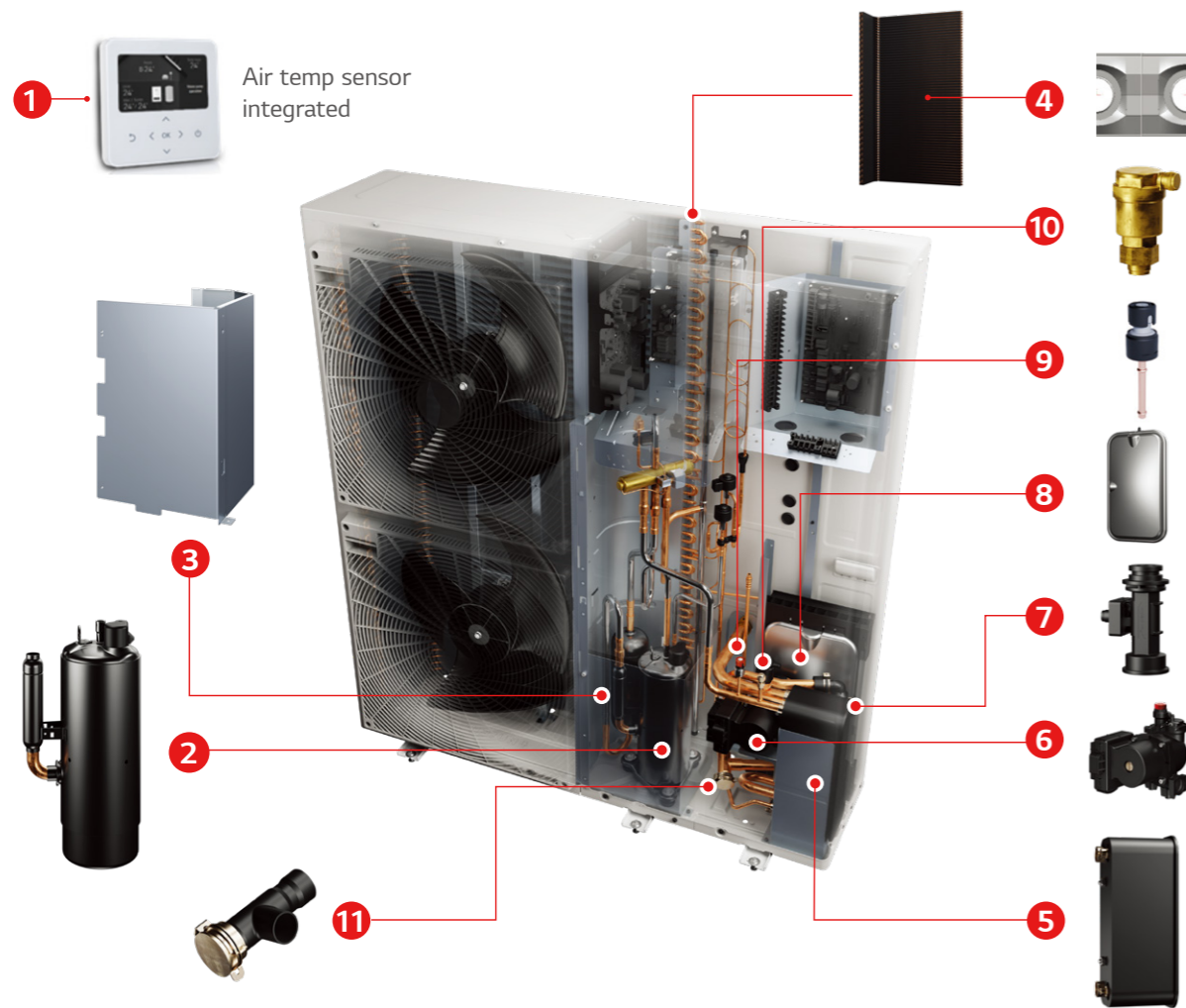

Components

- 1) Standard III remote controller ¹⁾
- 2) R1 Compressor
- 3) Compressor noise shield
- 4) Black Fin heat exchanger (ref/air)
- 5) Plate type heat exchanger (ref/water)
- 6) Water pump
- 7) Water flow sensor
- 8) Expansion vessel (8 ℓ)
- 9) Water pressure sensor
- 10) Air vent valve
- 11) Strainer

1) The remote controller is supplied with the product, but it needs to be installed separately.

Product Dimensions

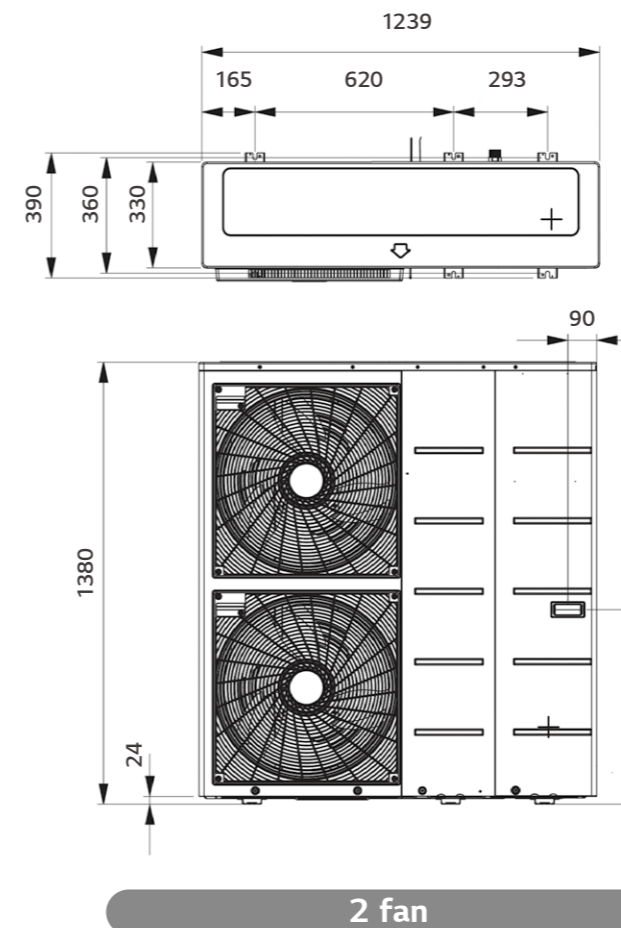
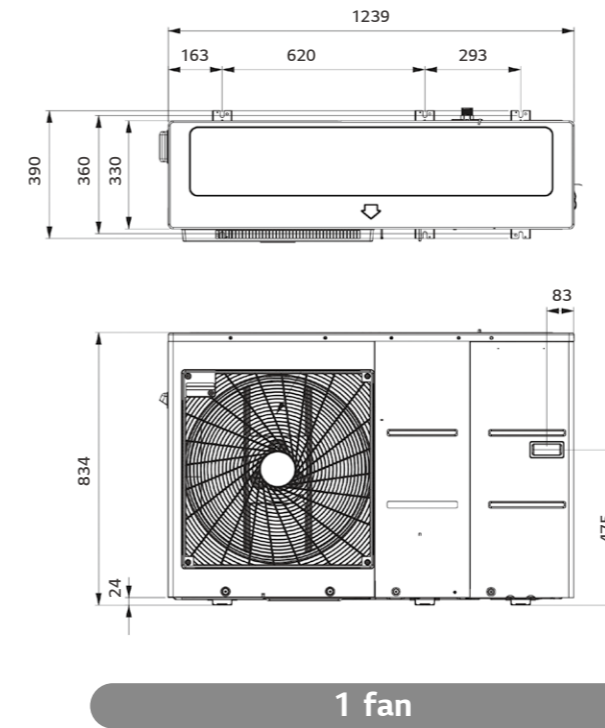

Installation
video tutorial



Installation guide step 1

Installation
video tutorial



Installation guide step 2